

TIMBER VAULTS

Concealment Furniture

CAUTION: You must swipe an RFID device to open and close the shelf.

Included Parts:

1. Metal wall bracket
2. Drywall wall anchors and screws
3. Concealment shelf
4. One RFID card
5. Lock pin and bolts
6. Battery back-up
7. One RFID Coin
8. One RFID Key Fob

1.

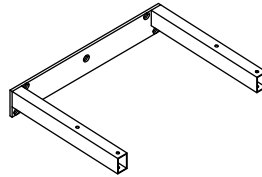

4.

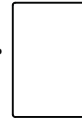

7. ○

2.



(qty. varies by shelf size)

5.

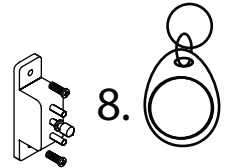

8.

3.

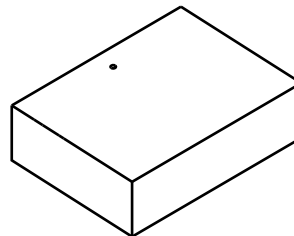

6.

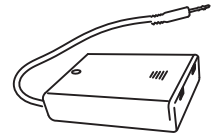

Installation Instructions:

1. Mount the metal wall bracket to your wall using the supplied hardware and make sure it is level.
2. For safety purposes, mount at least one screw on the left and right directly into a wall stud.
3. Slide the shelf onto the metal tubes.
4. Install the 4x phillips wood screws through the interior metal tubes into the shelf sides.
This locks the shelf onto the bracket.

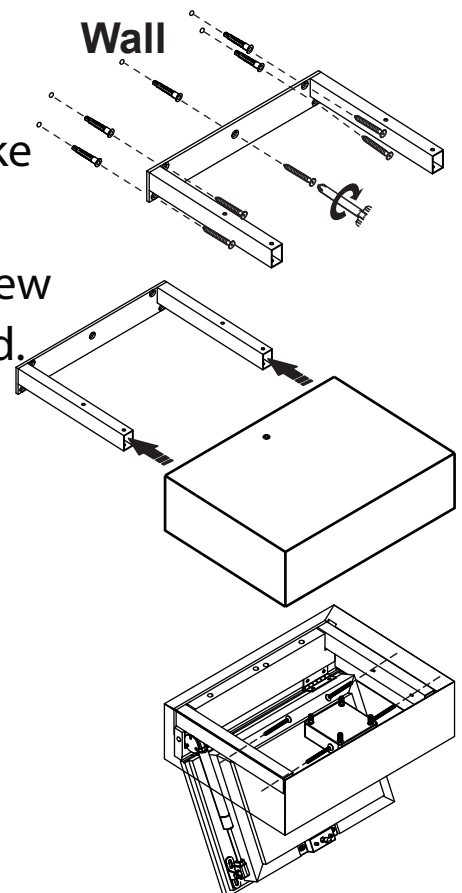

TIMBER VAULTS

—◇ Concealment Furniture ◇—

Lock Pin Installations:

1. Place lock pin on the lock pins wooden pedestal inside the cabinet.

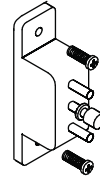

2. Insert both Philips head bolts and tighten.
Note: You may need to fine tune the lock pin by loosening the the screws and slightly shifting the pin to one side until the pin is perfectly aligned with the lock base.

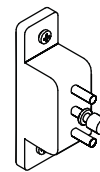

3. Install your batteries into the lock and install the battery cover.
(4 x AAA Batteries not included).

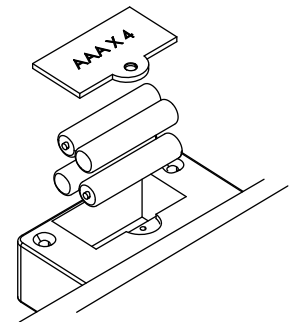

How To Operate the Lock:

1. Swipe your RFID device over the wooden surface covering the lock. The lock will beep and open. Depending on the weight, you may need to press the bottom of the shelf up to fully unlock.
 2. Swipe your RFID device again, the lock will beep once and you may close the cabinet. **(you must swipe your card to close).**
- * **YOU MUST OPEN & CLOSE THE SHELF WITH THE SAME RFID DEVICE.**
 - * **THE LARGE SIZE SHELF MAY REQUIRE YOU TO DEPRESS THE BOTTOM PANEL TO OPEN.**